

日期/Date
 档案员
 Filing Clerk

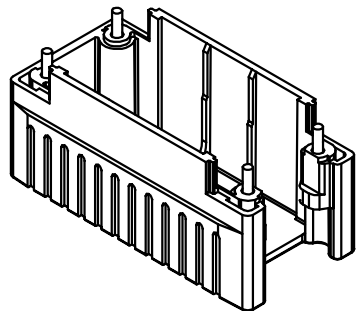
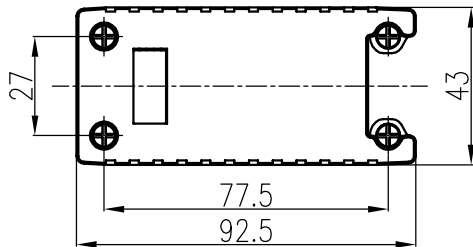
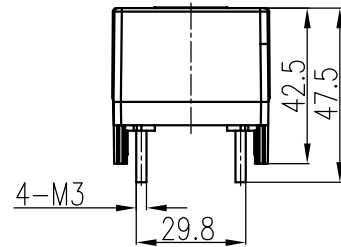
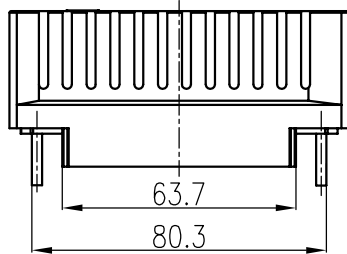

技术参数:

- 材料: 聚碳酸酯
- 颜色: RAL 7032 (浅灰色)
- 对插芯起到防护作用

Technical specification:

- Material: polycarbonate
- Colour: RAL 7032(light grey)
- Play the protective role for insert

						表面处理 Finish	-				图号 Drawing No.	-
						材料 Material	-				产品代号 Part Code	CC16B-CV
标记 Mark	处数 Number	变更描述/Description			签名 Signature		日期 Date					产品料号 Part No.
	姓名/Name	日期/Date		姓名/Name	日期/Date	比例 Scale	版本 REV.	重量 Weight	数量 Qty.	产品名称 Part Name		
绘图 Drawn	BQ LUO	18.10.2010	标准化 Stand.	-	-	1:2	V1.0	147.9g	-	-		
审核 Checked	P RAO	18.10.2010								-		
工艺 Process	-	-	批准 Approved	YY LIN	18.10.2010			All Dimensions in mm Original Size DIN A 4		厦门唯恩电气有限公司 XIAMEN WAIN ELECTRICAL CO.LTD		