

M公制螺纹/Metric Thread										
序号 No.	产品名称 Part code	产品料号 Part NO.	螺纹规格AG Thread size	配用软管d Fits to tubing size	扳手尺寸SW Wrench size	螺纹长度GL Thread length	内孔D1 Bore	外径直径D External diameter	总长L Total length	重量/Weight g
1	WNCP-M12B/AD10.0	1021150112002	M12*1.5	AD10.0	15	10	8	17	34.5	8
2	WNCP-M16B/AD13.0	1021150132002	M16*1.5	AD13.0	18	9.5	11.5	20	34.5	9.6
3	WNCP-M18B/AD15.8	1021150142002	M18*1.5	AD15.8	21	9.5	14	23	36.5	11.8
4	WNCP-M20B/AD18.5	1021150152002	M20*1.5	AD18.5	24	11	14.5	26	39	15.9
5	WNCP-M20B/AD21.2	1021150152004	M20*1.5	AD21.2	26.5	13	15	29.5	44	9.9
6	WNCP-M25B/AD21.2	1021150182002	M25*1.5	AD21.2	26.5	13	18	29.5	44.5	11.5
7	WNCP-M25B/AD28.5	1021150182004	M25*1.5	AD28.5	33.5	13	20.5	37	47	15.2
8	WNCP-M32B/AD28.5	1021150192002	M32*1.5	AD28.5	33.5	13	24	37	47	17.4
9	WNCP-M32B/AD34.5	1021150192004	M32*1.5	AD34.5	39.5	11.5	26.5	43.5	48	20.6
10	WNCP-M40B/AD34.5	1021150202002	M40*1.5	AD34.5	39.5	11.5	30	43.5	48	24.3
11	WNCP-M40B/AD42.5	1021150202004	M40*1.5	AD42.5	48	14	34	51	52	85
12	WNCP-M50B/AD42.5	1021150462002	M50*1.5	AD42.5	48	13.5	40	51	52	34.2
13	WNCP-M50B/AD54.5	1021150462004	M50*1.5	AD54.5	59	13.5	44.5	63.5	53.5	41.3
14	WNCP-M63B/AD54.5	1021150482002	M63*1.5	AD54.5	59	14.5	55	63.5	53.5	43

PG制螺纹/PG Thread										
序号 No.	产品名称 Part code	产品料号 Part NO.	螺纹规格AG Thread size	配用软管d Fits to tubing size	扳手尺寸SW Wrench size	螺纹长度GL Thread length	内孔D1 Bore	外径直径D External diameter	总长L Total length	重量/Weight g
1	WNCP-PG7B/AD10.0	1021150012002	PG7	AD10.0	15	10	8	17	34.5	3.8
2	WNCP-PG9B/AD13.0	1021150022002	PG9	AD13.0	18	9.5	11.5	20	34.5	4.9
3	WNCP-PG11B/AD15.8	1021150032002	PG11	AD15.8	21	9.5	14	23	36	6.1
4	WNCP-PG13.5B/AD18.5	1021150042002	PG13.5	AD18.5	24	11	16	26	39	8
5	WNCP-PG16B/AD21.2	1021150052002	PG16	AD21.2	26.5	13	18.5	29.5	44.5	10
6	WNCP-PG21B/AD28.5	1021150062002	PG21	AD28.5	34	13	23.5	37	47	15.4
7	WNCP-PG29B/AD34.5	1021150072002	PG29	AD34.5	39	11.5	31	43.5	47	21.1
8	WNCP-PG36B/AD42.5	1021150082002	PG36	AD42.5	48	14	40.5	51	52.5	29

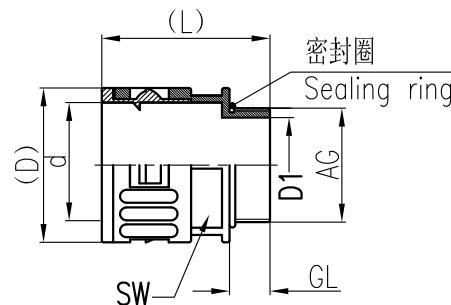
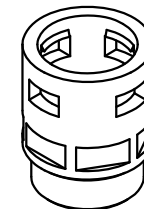

技术参数:

- 材料:

- 主体: PA
- 密封元件: 丁腈橡胶

- 颜色: 黑色

- 温度范围: -40°C-100°C,短时间可以达到120°C

Technical specification:

- Material:

- Body: PA
- Sealing: NBR

- Colour: black

- Temperature range: -40°C-100°C, short-term 120°C

表面处理 Finish	-			图号 Drawing No.	-		
材料 Material	-			产品代号 Part Code	WNCP-M63B/AD54.5		
	-			产品料号 Part No.	1021150482002		
比例 Scale	版本 REV.	重量 Weight	数量 Qty.	产品名称 Part Name	-		
1:1	V1.1	43g	-	厦门唯恩电气有限公司 XIAMEN WAIN ELECTRICAL CO.LTD			
All Dimensions in mm Original Size DIN A 4							
标记 Mark	处数 Number	变更描述/Description		签名 Signature	日期 Date		
绘图 Drawn	BQ LUO	姓名/Name	日期/Date	姓名/Name	日期/Date		
审核 Checked	P RAO	18.10.2010	标准化 Stand.	-	-		
工艺 Process	-	-	批准 Approved	YY LIN	18.10.2010		